

MotorPro

New paradigm for Motor Design



KOMOTEK

Overview

MotorPro is a software package dedicated to electric motors for analyzing/designing of motor. It combines conventional analysis method, magnetic-equivalent circuit method, and finite element method with the latest computer technology. The user is able to select what he/she wants and changes the variables to analyze/design the new motor with the libraries which contain information of shape of motor (rotor, stator, winding), materials and output forms. MotorPro doesn't require any finite element skills because all finite element processes are automated. Improved graphic user interface and various utility functions will provide what the motor developer/designer want in shorter, easier and clearer.

Modules

BLDC

→ Module for Brushless DC and PMAC motor

SRM

→ Module for Switched Reluctance Motor

PMDC

→ Module for Permanent Magnet DC motor

MESpice

→ Module for generating library for circuit simulator

PreModel

→ Module for arbitrary shape design

Fields

- Motor manufacturing
- System engineering
- Education
-

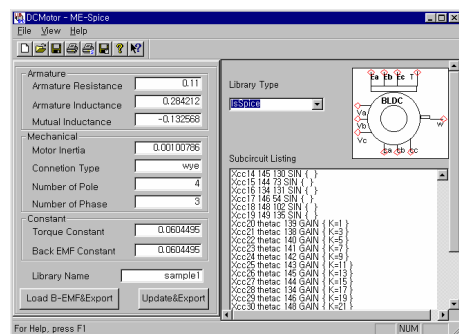
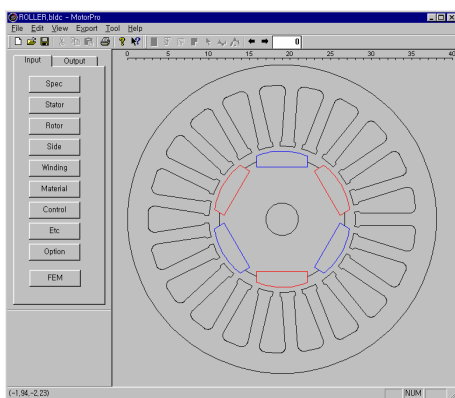
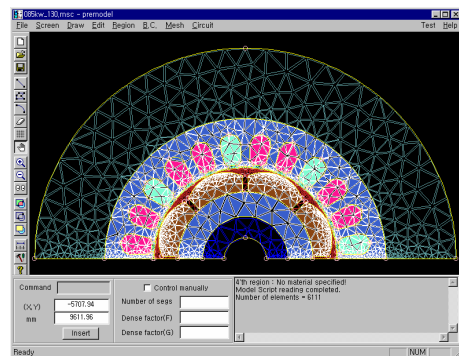
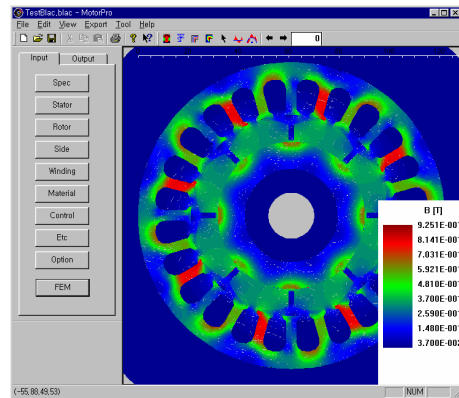

Features

Graphic User Interface

Model Library

- slot
- rotor

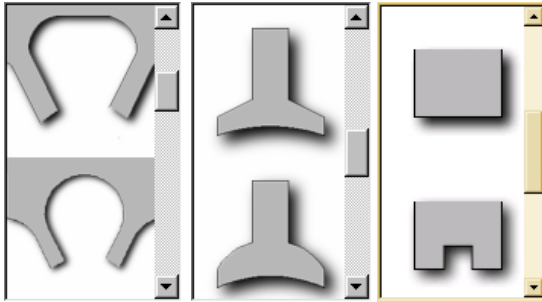

Material D.B.

- steel
- magnet (ferrite, neodymium, samarium, alnico)

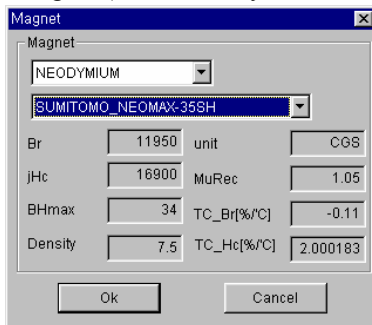

- wire

Winding Design

- support automatic winding
- easy to check MMF

Interface with AutoCAD

- import slot/rotor shape in type of AutoCAD's dxf
- export basic drawing's for motor into type of AutoCAD's dxf

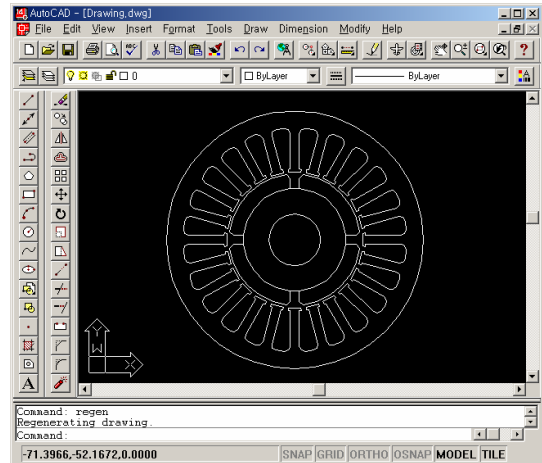

Dynamic Characteristic

- torque, speed and current versus time

Fully Automated FEM

- you can get FEA results with a few clicks using FEA wizard

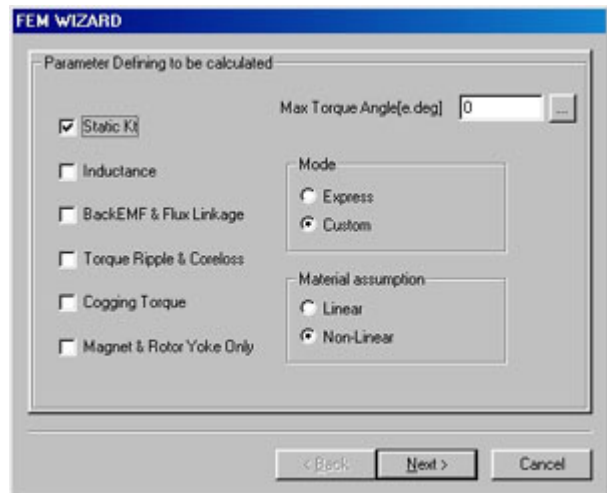

BLDC

- Input

- specifications
- stator

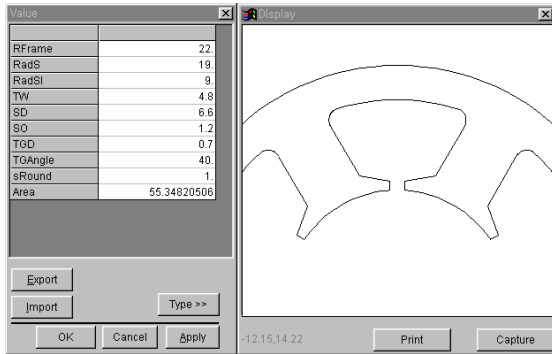

- rotor which includes magnet shape and direction
- side
- winding

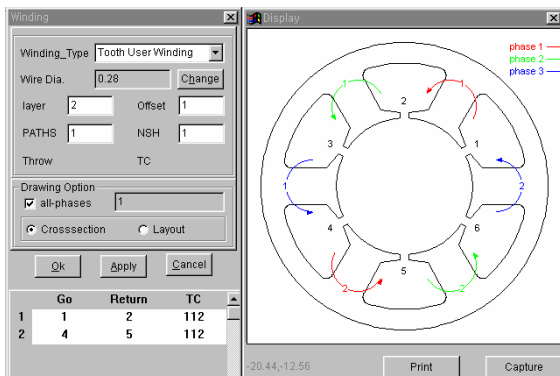

- materials (magnets, steel)
- electrics (DC / AC)

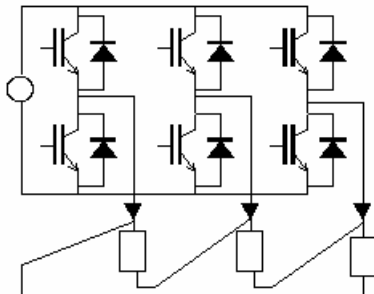

- etc & adjustment factors

- FEM Wizard

- airgap flux density
- cogging torque
- k_T and k_T profile
- inductance
- back-EMF
- coreloss

- Utility

- winding frame
- automatically get maximum torque angle
- ampere-conductor distributions
- MMF distributions

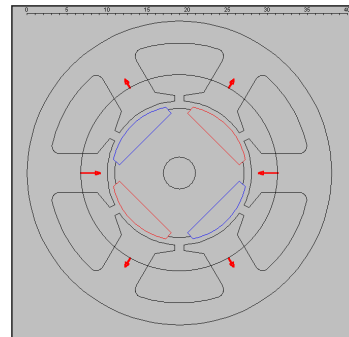

- Output

- all input parameters
- output parameters obtained by FEM and/or magnetic circuit analysis
- characteristic curve
- waveform such as airgap flux density, cogging torque, back-EMF and etc.

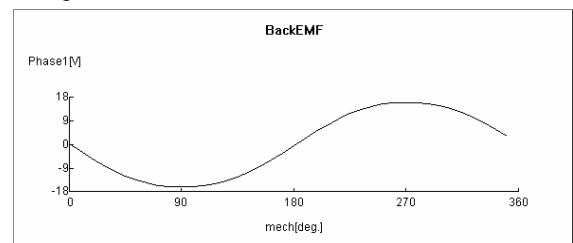

- dynamic characteristic curve
- FEM post processing
 - field lines and flux density distribution by rotating the rotor
 - flux density at point, on line and arc

PMDC

- Input
 - specifications
 - stator which includes magnet shape and direction

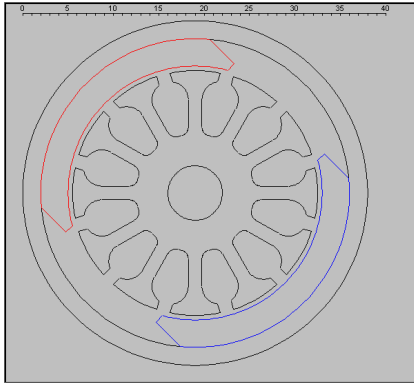

-
- rotor
- side
- winding which includes brush and commutator

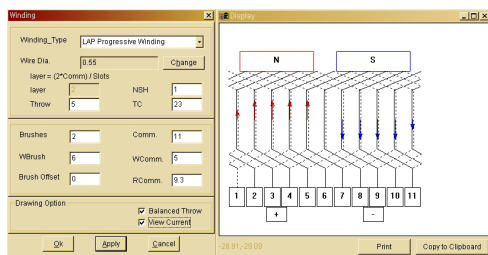

- materials (magnets, steel)
- electric

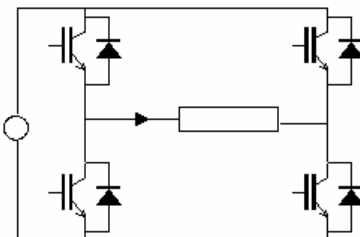

-
- etc & adjustment factors

- FEM Wizard
 - airgap flux density
 - cogging torque
 - k_T and k_E profile

- inductance
- back-EMF
- coreloss

- Utility
 - winding frame
 - ampere-conductor distributions
 - MMF distributions

- Output
 - all input parameters
 - output parameters obtained by FEM and/or magnetic circuit analysis
 - characteristic curve
 - waveform such as airgap flux density, cogging torque, back-EMF and etc.

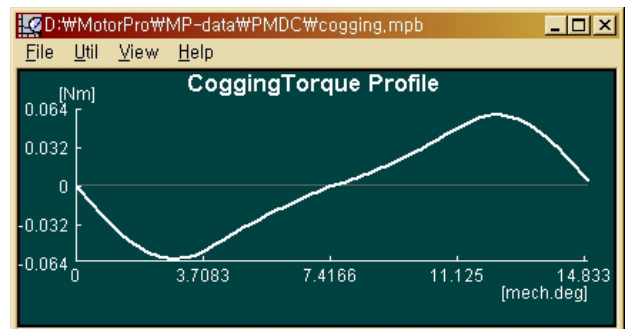

- dynamic characteristic curve
- FEM post processing
 - field lines and flux density distribution by rotating the rotor
 - flux density at point, on line and arc

SRM

- Input
 - specifications
 - stator
 - rotor

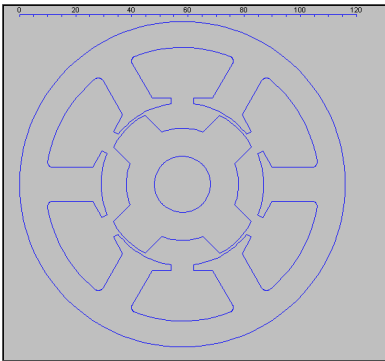

-
- side
- winding

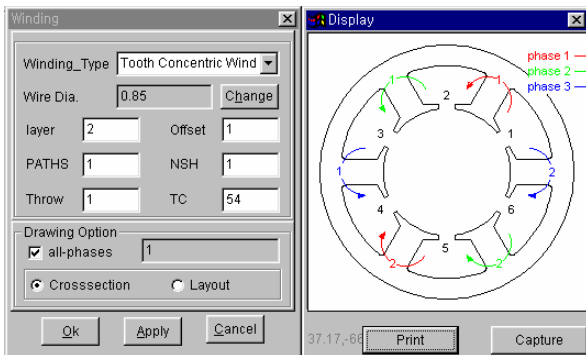

-
- materials (steel)
- electrics

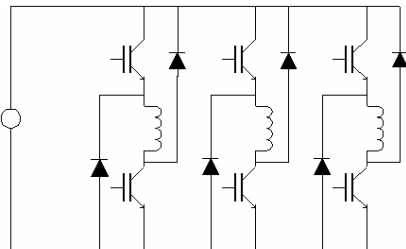

-
- etc & adjustment factors

- FEM Wizard
 - airgap flux density

- k_T and k_T profile
- inductance profile
- magnetization curve

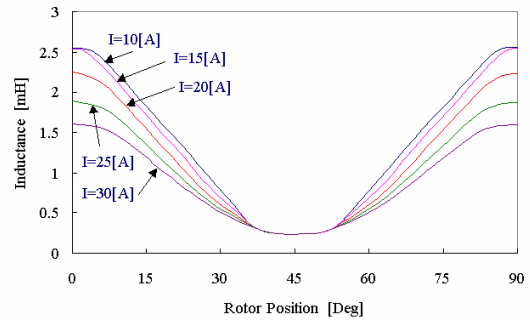

-
- coreloss

• Utility

- winding frame
- ampere-conductor distributions
- MMF distributions

• Output

- all input parameters
- output parameters obtained by FEM and/or magnetic circuit analysis
- waveform such as airgap flux density, magnetization curve
- dynamic characteristic curve
- FEM post processing
 - field lines and flux density distribution by rotating the rotor
 - flux density at point, on line and arc

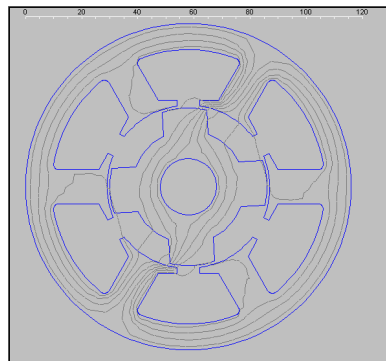

PreModel

Overview

The electric engineers with much interest in the numerical analysis of electromagnetic field look for their own field, which needs their knowledge. PreModel makes it possible to modify the motor in more details for the purpose of the numerical analysis of electromagnetic field and it will show impressive capability in add-on.

Features

- MotorPro add-on
- structure define and editing

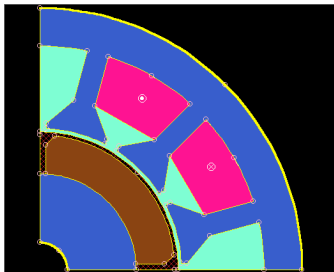

- material defining

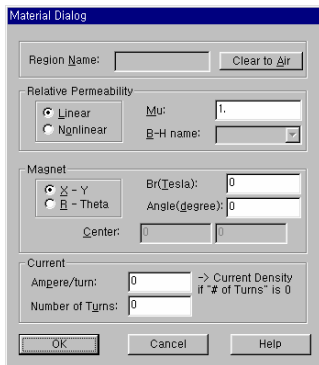

- import Autocad's DXF
- mesh refinement based on geometry complexity

ME-Spice

Overview

The control device and motor has close relation because of technological improvement of semi-conductor and power-electronic technology, and the motor requires the system to drive and control. However, it would be insufficient for engineers to spend much time to understand the sophisticated motor. ME-Spice can free the engineers from these kinds of problems as the motor library program for common motor control circuit simulator.

Features

- import MotorPro's MD file

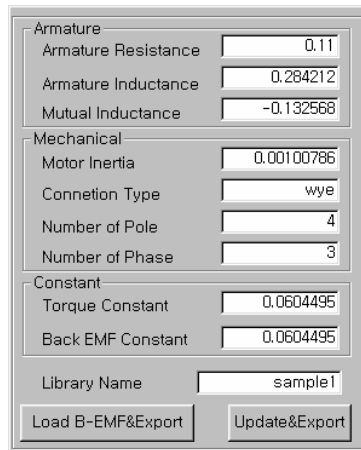

- Pspice

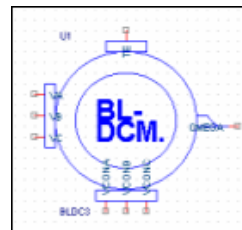

- Matlab Simulink

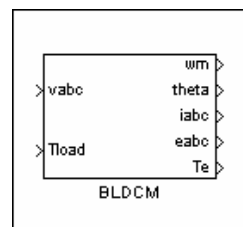

- ICAP/4

